

Register your product and get support at
www.philips.com/welcome

GoGear

SA1VBE02

SA1VBE04

SA1VBE08

SA1VBE16



EN User manual

PHILIPS

Contents

1 Important safety information	2
General maintenance	2
Recycling the product	3

2 Your new GoGear Vibe	5
What's in the box	5

3 Getting started	6
Overview of the controls and connections	6
Overview of the main menu	6
Install software	7
Connect and charge	7
Connect the GoGear Vibe to a computer	7
Battery level indication	7
Disconnect GoGear Vibe safely	8
Turn GoGear Vibe on and off	8
Automatic standby and shut-down	8

4 Use GoGear Vibe to carry files	9
---	---

5 Rhapsody®	10
Add Rhapsody® music channels to GoGear Vibe	10
Add pictures to GoGear Vibe	11

6 Music	12
Listen to music	12
Find your music	12
Delete music tracks	12

7 Audiobooks	13
Add audiobooks to GoGear Vibe	13
Audiobook controls	13
Select audiobook by book title	13

8 Video	14
Download, convert and transfer videos	14
Play videos	14
Delete videos	14

9 Pictures	15
View pictures	15
View slideshow	15
Add pictures to GoGear Vibe	15
Delete pictures	15

10 Radio	16
Listen to FM radio	16
Manually tune a radio station	16
Auto-tune preset radio station	16
Play a preset radio station	16

11 Recordings	17
Record audio/voices	17
Listen to voice/audio recordings	17
Upload your recordings to a computer	17
Delete recordings	17

12 Settings	18
--------------------	----

13 Update GoGear Vibe	20
Manually verify / update firmware	20

14 Troubleshooting	21
---------------------------	----

15 Technical data	22
System requirements	22
Supported music file formats	22
Supported video file formats	22
Supported picture file formats	23

16 Glossary	24
--------------------	----

Need help?

Please visit

www.philips.com/welcome

where you can access a full set of supporting materials such as the user manual, the latest software updates, and answers to frequently asked questions.

1 Important safety information

General maintenance

! Caution

- To avoid damage or malfunction:
- Do not expose the product to excessive heat caused by heating equipment or direct sunlight.
- Do not drop the product or allow objects to fall on your player.
- Do not allow the product to be submerged in water. Do not expose headphone socket or battery compartment to water, as water entering the set may cause major damage.
- Active mobile phones in the vicinity may cause interference.
- Back up your files. Ensure that you retain the original files you have downloaded to your device. Philips is not responsible for any loss of data if the product becomes damaged or not readable / legible.
- Manage (transfer, delete, etc.) your music files only with the supplied music software to avoid problems.
- Do not use any cleaning agents containing alcohol, ammonia, benzene, or abrasives as these may harm the product.

About operating and storage temperatures

- Operate in a place where temperature is always between 0 and 35°C (32 to 95°F)
- Store in a place where temperature is always between -20 and 45°C (-4 to 113°F).
- Battery life may be shortened in low temperature conditions.

Replacement parts/accessories:

Visit www.philips.com/support to order replacement parts/accessories.

Hearing Safety



Listen at a moderate volume:

Using headphones at a high volume can impair your hearing. This product can produce sounds in decibel ranges that may cause hearing loss for a normal person, even for exposure less than a minute. The higher decibel ranges are offered for those that may have already experienced some hearing loss.

Sound can be deceiving. Over time your hearing 'comfort level' adapts to higher volumes of sound. So after prolonged listening, what sounds 'normal' can actually be loud and harmful to your hearing. To guard against this, set your volume to a safe level before your hearing adapts and leave it there.

To establish a safe volume level:

Set your volume control at a low setting.

Slowly increase the sound until you can hear it comfortably and clearly, without distortion.

Listen for reasonable periods of time:

Prolonged exposure to sound, even at normally 'safe' levels, can also cause hearing loss.

Be sure to use your equipment reasonably and take appropriate breaks.

Be sure to observe the following guidelines when using your headphones.

Listen at reasonable volumes for reasonable periods of time.

Be careful not to adjust the volume as your hearing adapts.

Do not turn up the volume so high that you can't hear what's around you.

You should use caution or temporarily discontinue use in potentially hazardous situations.

Do not use headphones while operating a motorized vehicle, cycling, skateboarding, etc.; it may create a traffic hazard and is illegal in many areas.

Modifications

Modifications not authorized by the manufacturer may void user's authority to operate the product.

Copyright information

All other brands and product names are trademarks of their respective companies or organizations.

Unauthorized duplication of any recordings whether downloaded from the Internet or made from audio CDs is a violation of copyright laws and international treaties.

The making of unauthorized copies of copy-protected material, including computer programs, files, broadcasts and sound recordings, may be an infringement of copyrights and constitute a criminal offense. This equipment should not be used for such purposes.

The Windows Media and the Windows logo are registered trademarks of Microsoft Corporation in the United States and/or other countries.

Be responsible! Respect copyrights.



Be responsible
Respect copyrights

Philips respects the intellectual property of others, and we ask our users to do the same. Multimedia content on the internet may have been created and/or distributed without the original copyright owner's authorization. Copying or distributing unauthorized content may violate copyright laws in various countries including yours.

Compliance with copyright laws remains your responsibility.

The recording and transfer to the portable player of video streams downloaded to your computer is intended only for use with public domain or properly licensed content. You may only use such content for your private, non-commercial use and shall respect eventual copyright instructions provided by the copyright owner of the work. Such instruction may state that no further copies shall be made.

Video streams may include copy protection technology that prohibits further copying. For such situations the recording function will not work and you will be notified with a message.

Data logging

Philips is committed to improving the quality of your product and enhancing the Philips user experience. To understand the usage profile of this device, this device logs some info / data to the non-volatile memory region of the device. These data are used to identify and detect any failures or problems you as a user may experience while using the device. The data stored, for example, will be the duration of playback in music mode, duration of playback in tuner mode, how many times battery low was encountered, etc. The data stored do not reveal the content or media used on the device or the source of downloads. The data stored on the device are retrieved and used ONLY if the user returns the device to the Philips service center and ONLY to simplify error detection and prevention. The data stored shall be made available to user on user's first request.

Recycling the product

Your product is designed and manufactured with high quality materials and components, which can be recycled and reused. When you see the crossed-out wheel bin symbol attached to a product, it means the product is covered by the European Directive 2002/96/EC:



Never dispose of your product with other household waste. Please inform yourself about

the local rules on the separate collection of electrical and electronic products. The correct disposal of your old product helps prevent potentially negative consequences on the environment and human health.

! **Caution**

- Removal of the built-in battery invalidate the warranty and may destroy the product. The following instructions are disposal instructions at the end of the product's life.

Your product contains a built-in rechargeable battery covered by the European Directive 2006/66/EC, which cannot be disposed of with normal household waste. To safeguard the functionality and safety of your product, take your product to an official collection point or service centre where a professional can remove or replace the battery as shown:

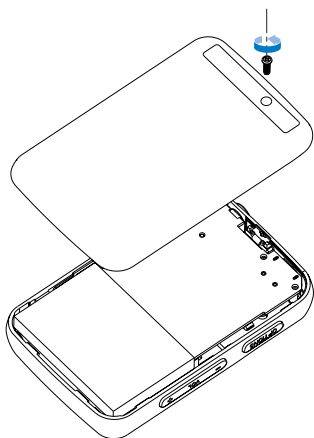

Please inform yourself about the local rules on separate collection of batteries. The correct disposal of batteries helps prevent potentially negative consequences on the environment and human health.

Notice for the USA

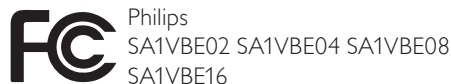

This equipment has been tested and found to comply with the limits for a Class B digital device, pursuant to part 15 of the FCC Rules.

These limits are designed to provide reasonable protection against harmful interference in a residential installation. This equipment generates, uses, and can radiate radio frequency energy and, if not installed and used in accordance with the instruction manual, may cause harmful interference to radio communications.

However, there is no guarantee that interference will not occur in a particular installation. If this equipment does cause harmful interference to radio or television reception, which can be determined by turning the equipment off and on, the user is encouraged to try to correct the interference by one or more of the following measures:

- Relocate the receiving antenna.
- Increase the separation between equipment and receiver.
- Connect the equipment into an outlet on a circuit different from that to which the receiver is connected.
- Consult the dealer or an experienced radio/TV technician for help.

2 Your new GoGear Vibe

GoGear Vibe allows you to

- play MP3 and WMA files
- view video files
- listen to FM radio
- make recordings

Quick start guide



Note

- The images serve as reference only. Philips reserves the right to change color/design without notice.

What's in the box

Check that you have received the following items:

Player



Earphones

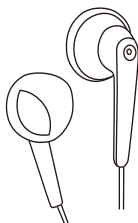

USB cable



3 Getting started

Overview of the controls and connections

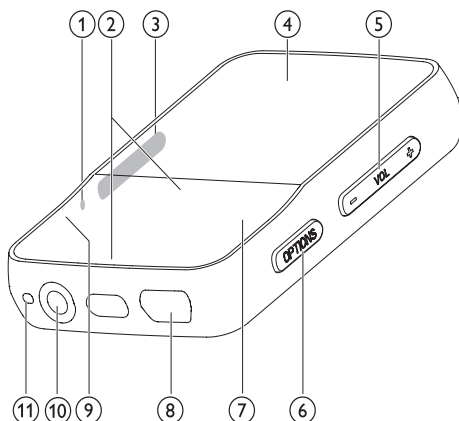

1	RESET	press: reset GoGear Vibe
2	▲ / ▼	press: scroll up/down press and hold: scroll up/down at high speed
3	⏻	slide and hold: turn GoGear Vibe on/off
	🔒	slide: lock/unlock all buttons except -VOL +
4		display
5	-VOL +	press: increase/decrease the volume press and hold: increase/decrease fast
6	OPTIONS	view available options
7	▶ 	press: play/pause
8	🔌	USB connection jack
9	⏪	press: back one level press and hold: scroll back at high speed
10	🎧	headphone jack
11	MIC	microphone

! Caution

- Listening to loud sounds for longer than a moment can be harmful to the listener.

You can set the volume level of GoGear Vibe to limit the maximum volume output.

- 1 From the main menu, select **[Settings]** > **[Sound settings]** > **[Volume limit]**.
- 2 Press the **- / +** volume controls to adjust the level.
- 3 Press **▶||** to confirm.
↳ When you set a volume limit, GoGear Vibe can no longer exceed the set volume, even if you press the volume **+** button.

To enable maximum volume again:

- 1 Select **[Settings]** > **[Sound settings]** > **[Volume limit]**.
- 2 Set the volume limit to maximum.
- 3 Press **▶||** to confirm.

Overview of the main menu

Menu	Mode	To
🎵	Music	play music tracks
📺	Video	play videos
🖼️	Pictures	view pictures
📻	FM radio	listen to FM radio
🎙️	Recording	create or listen to recordings
📁	Folder view	view files in folders
🎧	Rhapsody channels*	listen to your Rhapsody channels*
⚙️	Settings	customize the settings of GoGear Vibe
🎵	Now playing	show the current play screen

☰ Note

- * Rhapsody channels feature requires an active Rhapsody account.

Install software

GoGear Vibe comes with the following software:

- Philips Device Manager (helps you get firmware updates for GoGear Vibe)
- Media Converter for Philips (helps you convert and transfer video files for GoGear Vibe)
- Rhapsody® Media Player (helps you convert and transfer Rhapsody® media files for GoGear Vibe)

Important:

Remember to install the software provided in the supplied CD-ROM for music and/or video transfer.

Important: Before installing the software, check that your computer meets the requirements (see section **System requirements** in this user manual).

- 1 Connect GoGear Vibe to your computer.
- 2 Insert the CD that comes with GoGear Vibe into the CD-ROM drive of your computer.
- 3 Follow the on-screen instructions to complete the installation of the software.

If the installation program fails to start automatically:

- 1 Browse the CD contents with Windows Explorer.
- 2 Double click on the file that ends with '.exe'.

Connect and charge

GoGear Vibe has a built-in battery that can be charged through the USB port of a computer (USB cable included).

Note





- For first-time use, allow GoGear Vibe to charge for 3 hours.
- The charging animation stops and the  icon is displayed when the charging process is completed.

Connect the GoGear Vibe to a computer

- 1 Connect the USB plug of the supplied USB cable to a spare USB port on your computer.
- 2 Connect the small USB plug of the USB cable to the small USB jack on GoGear Vibe.
- 3 Turn on your computer.
↳ GoGear Vibe charges.

Battery level indication

The display indicates the approximate levels of the battery status as follows:

				
100%	75%	50%	25%	0%

- ↳ A flashing battery screen indicates that the battery is low. The player saves all settings and switches off within 60 seconds.

Note

- Rechargeable batteries have a limited number of charge cycles. Battery life and number of charge cycles vary by use and settings.
- The charging animation stops and the  icon is displayed when the charging process is completed.



Tip

- You can conserve battery power and increase the play time of the GoGear Vibe if you go to *** > [Display settings] > [Screen off timer]** and ensure that the shortest timer setting is selected.

Disconnect GoGear Vibe safely

To avoid data loss, disconnect GoGear Vibe from your computer as follows:

- 1 On your computer, exit all applications that are working with GoGear Vibe.
- 2 Click  in the task tray of your computer.
- 3 Wait for the confirmation that GoGear Vibe can be safely removed, then disconnect GoGear Vibe from the USB port.

Turn GoGear Vibe on and off

- 1 To toggle between modes on and off, slide and hold  for approximately 2 seconds.

Automatic standby and shut-down

GoGear Vibe has an automatic standby and shut-down feature that can save battery power.

After 10 minutes in idle mode (no music plays, no button is pressed), GoGear Vibe turns off.

- 1 Slide and hold  for approximately 2 seconds to turn GoGear Vibe on again.

GoGear Vibe has a lock switch to prevent accidental operation.

- 1 To lock the buttons when you play, move the slider to position 
 - ↳ All buttons except the volume keys are locked and the display shows a lock icon.
- 2 To unlock the buttons again, move the slider to the center position.

4 Use GoGear Vibe to carry files

GoGearVibe allows you to carry files in **Windows Explorer**.

- 1** With GoGear Vibe connected to the USB port of the computer, open **Windows Explorer**.
- 2** Create folders in GoGear Vibe.
- 3** Use drag and drop actions to sort your files into the folders.

5 Rhapsody®

Depending on the type of Rhapsody® account you hold, you can add Rhapsody® Music to GoGearVibe using **Rhapsody® Media Player**. For more information visit www.Rhapsody.com. You need to install the **Rhapsody® Media Player** before you continue:

- 1 Ensure the computer is connected to the Internet.
- 2 Connect GoGear Vibe to the computer.
- 3 Launch **Rhapsody® Media Player**.
- 4 In the main window, select the tab Music Guide.
- 5 In the main window, select an album and song title.
- 6 In the main window, click the + icon to add the title to My Library.
- 7 In the Sources window, select My Library.
- 8 From the main window, drag and drop your music to GoGear Vibe icon in the Sources window.

Note

- This feature is available only for music that you purchased through Rhapsody®.

Tip

- You can check the status of your Rhapsody® account in the **Settings** menu of GoGear Vibe, or visit the Internet at www.Rhapsody.com.

Add Rhapsody® music channels to GoGear Vibe

Depending on the type of Rhapsody® account you hold, you can add Rhapsody® music channels to GoGearVibe using Rhapsody® Music Player: For more information visit www.Rhapsody.com

- 1 Ensure the computer is connected to the Internet.
- 2 Connect GoGear Vibe to the computer.
- 3 Launch **Rhapsody® Media Player**.
 - ↳ GoGearVibe is shown in the Sources window on the left hand side of the screen.
- 4 In the main window, select the tab Channel Guide.
- 5 In the main window, click on the + icon to add a channel to My Channels.
- 6 In the Sources window, select My Channels.
 - ↳ The main window shows a list of your channels.
- 7 Drag and drop your channels to the GoGear Vibe icon in the Sources window.

Note

- This feature is available only if you subscribe to Rhapsody® Music Channels.

When you transfer Rhapsody® Channels to GoGearVibe, the  (Rhapsody® music channels) icon appears in the home menu.

- 1 From the main menu, select  icon to enter Rhapsody® music channels.
- 2 Press ▲ / ▼ to scroll through the list of items that are available to you.
- 3 Press ▶|| to play or press ↶ to return to previous level.

Note

- This feature is available only if you subscribe to Rhapsody® music channels.



Add pictures to GoGear Vibe

You can transfer picture files from a computer to GoGear Vibe using **Rhapsody® Media Player**. You need to install the **Rhapsody® Media Player** before you continue:

- 1 Connect GoGear Vibe to the computer.
- 2 Launch **Rhapsody® Media Player**.
 - ↳ GoGear Vibe is shown in the Sources window on the left hand side of the screen.
- 3 In the Sources window, select My Library.
- 4 In the main window, click on a tab to select Photos.
- 5 To add pictures from a different folder on your computer, click on the Add Photos icon.
- 6 In the Add Media to My Library pop-up window, check the box next to Scan for photos in this folder:.
 - ↳ By default, the pop-up window shows the pictures in the My Pictures folder on your computer.
- 7 Click Browse... to find the folder with your pictures, if it is different from the preselected folder.
- 8 Click Import, to import the selected folder to My Library.
- 9 To transfer the picture files to GoGear Vibe, drag and drop the files from the main window to the GoGear Vibe icon in the Sources window.

6 Music

Listen to music

- 1 From the main menu, select  to enter music mode.
- 2 Navigate the sub-menus to select your music.
- 3 Press  to play.
 - Press  to toggle between pause and play.

Find your music

From the main menu, select  to enter music mode.
GoGearVibe offers the following menu options:

[All songs]

- Alphabetically listed tracks

[Artists]

- Alphabetically listed artists
- Alphabetically listed albums
- Tracks listed in album order

[Albums]

- Alphanumerically listed albums
- Tracks listed in album order

[Playlists]



- [Playlist-on-the-go]
- Tracks listed in playlist order



Note

- Alternatively, you can select  from the main menu and find your files in folder view.

Delete music tracks

- 1 From the main menu, select .
- 2 Press  /  to locate a track.
- 3 Press **OPTIONS** to view options menu.
- 4 Select the delete option to delete the track.

7 Audiobooks

GoGear Vibe supports books in audio format. The use of this feature requires that you download the **AudibleManager** from audible.com. With the **AudibleManager** you can manage the digital contents of your audiobooks. Visit audible.com and register. The onscreen instructions guide you through the **AudibleManager** software download process. While you listen to an audiobook, you can navigate the same way as you would in any other audio file.

Add audiobooks to GoGear Vibe

- **Important:** GoGear Vibe supports audiobook format 4.
- 1 On your computer, launch **AudibleManager**.
 - 2 Follow the online instructions to download your audiobooks in format 4.
 - 3 Follow the **AudibleManager** on-screen instructions to activate GoGear Vibe for your audiobooks.
 - 4 Follow the **AudibleManager** on-screen instructions to transfer your audiobooks to GoGear Vibe.

Note

- GoGear Vibe can only play audiobooks in format 4.
- GoGear Vibe can only play audiobooks for which it is **activated**.

Audiobook controls

GoGear Vibe offers the following audiobook mode controls:

Goal	Action
Play / pause	Press ►►
Skip forward to beginning of new section / chapter	Press ►
Skip back to beginning of current section / chapter	Press ◀
Fast skip forwards through audiobook	Press and hold ►
Fast skip backwards through audiobook	Press and hold ◀
Return to browsing menu	Press ↶
Increase / decrease volume	Press – VOL +

Tip

- You can resume play after navigating away from audiobooks (see section **Resume play** in this user manual).

Select audiobook by book title

- 1 From the main menu, select  to enter music mode.
- 2 Press ▲ or ▼, then ►► to select **Audiobooks**.
- 3 Press ▲ or ▼ to select title, then ►► to play.
↳ To exit, press ↶.

8 Video

Download, convert and transfer videos







MediaConverter™ for Philips enables you to

- download videos from the Internet to your PC at the click of a button.
- convert video files on your PC to the correct screen size of GoGear Vibe.
- transfer converted videos from your PC to GoGear Vibe.





Note

- Video conversion and transfer can take a long time, depending on your PC configuration.

Play videos

- 1 From the main menu, select  to enter video mode.
- 2 Navigate the sub-menus to select your video.
- 3 Press  to play.
 - Press  to toggle between pause and play.
- 1 During video play, press and hold  /  to scan fast forward / backward.
 - Press  to resume play.

Delete videos

- 1 From the main menu, select  to enter video mode.
- 2 Press  /  to locate a video.
- 3 Press  to play.
- 4 Press **OPTIONS** to view options menu.
- 5 Select the delete option to delete the video.



Note

- Alternatively, you can select  from the main menu and find your files in folder view.

9 Pictures

View pictures

GoGear Vibe supports a range of picture formats (see section **Supported formats** in this user manual).

- 1 From the main menu, select  to enter picture mode.
- 2 Press  /  to move to next / previous picture.

View slideshow

While in  mode, you can view your pictures as a slideshow:

- 1 Press  to start the slideshow.





Tip

- The menu **Settings** offers various slideshow settings.

Add pictures to GoGear Vibe

- 1 With GoGear Vibe connected to the USB port of the computer, open **Windows® Explorer**.
- 2 Create folders in GoGear Vibe.
- 3 Use drag and drop actions to sort your pictures into the folders.

Delete pictures

- 1 From the main menu, select  to enter picture mode.
- 2 Press  /  to locate a picture.
- 3 Press **OPTIONS** to view options menu.
- 4 Select the delete option to delete the picture.



Note

- Alternatively, you can select  from the main menu and find your files in folder view.





10 Radio

Listen to FM radio

- 1 From the main menu, select  to enter radio mode.
 - The earphones cable acts as FM antenna.



Manually tune a radio station

While in  mode, you can manually tune to a radio station:







- 1 To search for the next stronger signal, press and hold  / .
- 2 To fine tune the frequency, briefly press  / .

Auto-tune preset radio station

The auto-tune feature of GoGear Vibe helps you find radio stations and save them under the preset numbers.

- 1 While in  mode, select **[Auto tune]** > **[Yes]**.
 - ↳ The radio automatically tunes radio stations and saves the frequencies to presets.
 - ↳ There are 20 presets available.
 - ↳ To stop auto tuning, press .
 - ↳ To exit radio, press and hold  for 2 seconds.

Play a preset radio station

- 1 In  mode, you can play previously set radio stations (presets):
- 2 Press **OPTIONS** to view options menu.
- 3 Select preset.
- 4 Press  /  to change to another preset.
- 5 To search for the next stronger signal, press and hold  /  for 2 seconds.
 - To exit radio, press and hold  for 2 seconds.







Note

- You can play presets only after you have stored radio stations under presets. (See **Auto-tune preset radio stations** or **Manually tune a radio station** in this user manual.)

11 Recordings

Record audio/voices

This is how you can record audio/voices with the built-in microphone (see section **Overview** for location of built-in microphone):

- 1 From the main menu, select  to enter recordings mode.
- 2 Select **[Start voice recording]**.
 - Press  to toggle between pause and record.
- 3 Press  to stop.
 - ↳ The screen prompts you to save the recording.
- 4 Press  to select **[Yes]** / **[No]**.
- 5 Press  to save the recording.
 - ↳ Recordings are saved on the player. (Filename format: VOICEXXX.MP3, where XXX is the recording number that is generated automatically.)



Tip

- You can find your recordings under **[Recordings library] > [Voice]**.

Upload your recordings to a computer



- 1 Connect GoGear Vibe to the computer (for instructions see section **Connect**).
- 2 On the computer, in **Windows® Explorer** select GoGear Vibe.
- 3 Select **Recordings > Voice**.
- 4 Copy and paste the recordings to any location on the computer.

Delete recordings

Use a computer to delete recordings from GoGear Vibe:

- 1 Connect GoGear Vibe to the computer (for instructions see section **Connect**).
- 2 On the computer, in **Windows® Explorer** select GoGear Vibe.
- 3 Select **Recordings > Voice**.
- 4 Select the recordings you want to delete.
- 5 On the computer, press **Delete**.
 - ↳ The selected recordings are deleted.

Listen to voice/audio recordings

- 1 From the  menu select **[Recordings library] > [Voice]**.
- 2 Select a recording.
- 3 Press  to play your recording.

12 Settings

This is how you customize GoGearVibe:

From the main menu, select ***** to enter settings mode.

In the ***** menu, navigate as follows:

- 1 Press **▲** / **▼** to select an option.
- 2 Press **▶||** to confirm a selection and go to the next level (when available).
- 3 Press **↶** to return to the previous level.
- 4 Press and hold **↶** to exit the ***** menu.

In the ***** menu, the following options are available:

Settings	Options menu	Sub-options menu
[Play mode]	[Repeat]	<ul style="list-style-type: none">• [Repeat off] (default)• [Repeat 1]• [Repeat all]
	[Shuffle]	<ul style="list-style-type: none">• [Shuffle off] (default)• [Shuffle all]
[Sound settings]	[Equalizer]	<ul style="list-style-type: none">• [Off] (default)• [Rock]• [Funk]• [Hip hop]• [Jazz]• [Classical]• [Techno]• [Custom]
	[Volume limit]	Vertical bar indicator. Press - VOL + to adjust volume limit, then press ▶ to confirm.
[Sleep timer]	<ul style="list-style-type: none">• [Off] (default)• xx [mins]	

[Display settings]	[Brightness]	Vertical bar indicator. Press ▲ or ▼ to adjust brightness, then press ► to confirm	
	[Theme]	<ul style="list-style-type: none"> • [Dark] (default) • [Red] • [Light] 	
	[Backlight timer]	• [[x] seconds]	
	[Screen off timer]	<ul style="list-style-type: none"> • [[x] seconds] • [Always on] 	
	[Screensaver]	<ul style="list-style-type: none"> • [Off] (default) • [Song title] • [Album art] • [Analog clock] • [Digital clock] • [Demo mode] 	
[Date and time]	[Time settings]	<ul style="list-style-type: none"> • [Set time format] • Set time 	
	[Date settings]	<ul style="list-style-type: none"> • [Set date format] • Set date 	
[Slideshow settings]	[Time per slide]	• [[x] seconds]	
	[Repeat]	<ul style="list-style-type: none"> • [Off] (default) • [On] 	
	[Shuffle]	<ul style="list-style-type: none"> • [Off] (default) • [On] 	
[Language]	<ul style="list-style-type: none"> • [English] (default) • Czech • Greek • German • Spanish • French • Italian • Hungarian 	<ul style="list-style-type: none"> • Dutch • Norwegian • Polish • Portuguese • Portuguese (Brazilian) • Russian • Slovak • Finnish 	<ul style="list-style-type: none"> • Swedish • Turkish • Simplified Chinese • Traditional Chinese • Japanese • Korean • Thai (/97 version only)
[Connect PC preference]	<ul style="list-style-type: none"> • [MSC] • [MTP] (default) 		
[Information]	<ul style="list-style-type: none"> • [Capacity:] • [Free space:] • [Firmware version:] • [Model:] • [Support site:] • [Rhapsody information] 		
[Factory settings]	[Restore factory settings? (Files transferred to player will not be affected.)]	<ul style="list-style-type: none"> • [Yes] • [No] 	

13 Update GoGear Vibe

GoGear Vibe is controlled by an internal program called firmware. Newer versions of the firmware may have been released after you have purchased GoGear Vibe.

The software program called **Philips Device Manager** can use your computer to check for firmware updates that are available on the Internet.

Install **Philips Device Manager** on your computer from GoGear Vibe or download the latest version from www.philips.com/support.

Note

- Your music files are not affected by a firmware update.

- 6 Disconnect GoGear Vibe from the computer.
 - ↳ GoGear Vibe restarts after the firmware is updated and is ready for use again.

Manually verify / update firmware

- 1 Ensure that your computer is connected to the Internet.
- 2 Connect GoGear Vibe to the computer (see section **Connect and charge** for instructions).
- 3 On your computer, click **Start > Programs > Philips Digital Audio Player > Vibe Device Manager** to launch **Philips Device Manager**.
- 4 Click **Update**
 - ↳ **Philips GoGear Vibe Device Manager** checks for updates and installs new firmware from the Internet, if available.
- 5 When the display shows **Update completed**, click **OK**.

14 Troubleshooting

If GoGear Vibe is not working properly or the display freezes, you can reset it without losing data:

How do I reset GoGear Vibe?

- Insert a pen tip or other object into the reset hole located at the left hand side of GoGear Vibe. Hold until the player shuts down.
- If the reset option is unsuccessful, follow the steps how to recover GoGear Vibe with the **Philips Device Manager**:
 - 1 On your computer, select **Start > Programs > Philips Digital Audio Player > Vibe Device Manager > Philips Device Manager** to launch the **Philips Device Manager**.
 - 2 Turn off GoGear Vibe before you continue.
 - 3 Press and hold the volume button **+** while you connect GoGear Vibe to your computer.
 - 4 Keep holding the key until the **Philips Device Manager** acknowledges GoGear Vibe and enters the recovery mode.
 - 5 On the computer, click the **Repair** button and follow the instructions of the **Philips Device Manager** to complete the recovery process.
 - 6 When the recovery is completed, disconnect GoGear Vibe from your computer.
 - 7 Restart GoGear Vibe.

15 Technical data

Power

Power supply: 290 mAh Li-ion polymer internal rechargeable battery
Play time¹ (music): 25 hours

Software on CD-ROM

Philips Device Manager: to restore and upgrade
Media Converter for Philips: to convert and transfer media files
Rhapsody® Media Player

Connectivity

Headphone 3.5 mm
USB 2.0 High speed

Sound

Channel separation: 45 dB
Frequency Response: 80 Hz - 18 kHz
Output power: 2 x 3 mW
Signal to noise ratio: > 84 dB

Audio playback

Compression format:
MP3 bit rates: 8 - 320 kps and VBR
MP3 sample rates: 8, 11.025, 16, 22.050, 24, 32, 44.1, 48 kHz
WMA bit rates: 5 - 192 kbps VBR
WMA sample rates: 8, 11.025, 16, 22.050, 24, 32, 44.1, 48 kHz
ID3-tag support
Audible format support

Video playback

SMV format support

Storage media

Built-in memory capacity²:
SA1VBE02 2GB NAND Flash
SA1VBE04 4GB NAND Flash
SA1VBE08 8GB NAND Flash
SA1VBE16 16GB NAND Flash

Music transfer³

Drag and drop in Windows® Explorer

Display

Color LCD 128 x 128 pixels

Note

- ¹ Rechargeable batteries have a limited number of charge cycles. Battery life and number of charge cycles vary by use and settings.
- ² 1GB = 1 billion bytes; available storage capacity is less. Full memory capacity may not be available as some memory is reserved for the player. Storage capacity is based on 4 minutes per song and 128 kbps MP3 encoding.
- ³ Transfer speed depends on operating system and software configuration.

System requirements

- Windows® XP (SP2 or above) / Vista
- Pentium III 800 MHz processor or higher
- 512 MB RAM
- 500 MB hard disk space
- Internet connection
- Windows® Internet Explorer 6.0 or later
- CD-ROM drive
- USB port

Supported music file formats

GoGearVibe supports the following music formats:

- MP3
- PCM
- ADPCM
- Audible
- WMA

Supported video file formats

GoGearVibe supports the following video formats:

- SMV

Supported picture file formats

GoGear Vibe supports the following picture formats:

- JPEG

16 Glossary

A

Album art

Album art is a feature that displays the artwork (cover picture) of a music album. This display enables the user to quickly identify a music album. The artwork files for music albums can be downloaded from the Internet.

C

Compression

In audio terms, this is a process of temporarily or permanently reducing audio data for more efficient storage or transmission. A temporary reduction in file size is called 'non-lossy' compression, and no information is lost. A permanent reduction in file size (such as with MP3 files) is called 'lossy' compression, and involves discarding unnecessary information which is irretrievably lost.

D

Decibel (dB)

A unit of measure used to express relative difference in power or intensity of sound.

Digital Audio

Digital Audio is a sound signal that has been converted into numerical values. Digital sound can be transmitted through multiple channels. Analog sound can only be transmitted through two channels.

F

FM (Frequency Modulation)

In radio broadcasting: a method of modulation in which the frequency of the carrier voltage is varied with the frequency of the modulation voltage.

J

JPEG

A very common digital still picture format. A still-picture data compression system proposed by the Joint Photographic Expert Group, which features small decrease in image quality in spite of its high compression ratio. Files are recognized by their file extension '.jpg' or '.jpeg'.

K

Kbps

Kilobits per second. A digital-data-rate measurement system which is often used with highly compressed formats such as AAC, DAB, MP3 etc. The higher the amount, the better the quality generally is.

L

LCD (Liquid Crystal Display)

Probably the most common way to show visual information on non-computer electronic equipment.

M

MHz (Mega Hertz)

One million cycles per second.

MP3

A file format with a sound data compression system. MP3 is the abbreviation of Motion Picture Experts Group 1 (or MPEG-1) Audio Layer 3. With the MP3 format, one CD-R or CD-RW can contain about 10 times more data than a regular CD.

P

PCM (Pulse Code Modulation)

Pioneering form of digital recording.

PlaysForSure*

PlaysForSure* is a Philips GoGear feature that ensures compatibility with Windows Media Player 10 and Windows XP. The PlaysForSure* logo assures the consumer that the music purchased at an online shop with this logo is compatible with the Philips GoGear player.

R**Rhapsody®**

Rhapsody® is an on-line music service that offers streaming on-demand access to its library of digital music.

S**Shuffle**

A feature that plays audio files (tracks) in random order.

SMV [SigmaTel Motion Video Format]

A partially compressed video format by SigmaTel that allows conversion of common PC motion video files for play on a portable multimedia player.

Stereo

Literally means solid. Usually taken to refer to two channel stereo, though developments in digital audio facilitate multichannel stereo.

SuperPlay

SuperPlay™ is a special feature of the product, which enables the listener to play all the music under a top-level library category, such as artists or albums, without having to select playlist items.

SuperScroll

SuperScroll™ is a navigation feature of the double-action search keys of the product. SuperScroll™ allows easy speed control when scrolling through large libraries to swiftly find items within large libraries. Longer press of the button results in faster scroll speed.

T**Thumbnail**

A thumbnail is reduced-size versions of a picture that is used to make it easier to recognize an them. Thumbnails serve the same role for images as a normal text index does for words.

V**Volume**

Volume is the most common word used to specify the control of relative loudness of sounds. It also pertains to the function on many electronic devices that is used to control the loudness.

W**WAV**

A format for sound files developed jointly by Microsoft and IBM. Built into Windows 95 to XP, which made it the de facto standard for sound on PCs. WAV sound files end with a '.wav' extension and works with nearly all Windows applications that support sound.

WMA (Windows Media Audio)

An audio format owned by Microsoft, is a part of Microsoft Windows Media technology. Includes Microsoft Digital Rights Management tools, Windows Media Video encoding technology, and Windows Media Audio encoding technology.

WMV [Windows Media Video]

Refers to a video compression technology developed by Microsoft Corporation. WMV content can be encoded by using Windows Media® Encoder 9 series. Files are recognised by their file extension '.wmv'.

